

SFIXL Ficha técnica y Tarifas

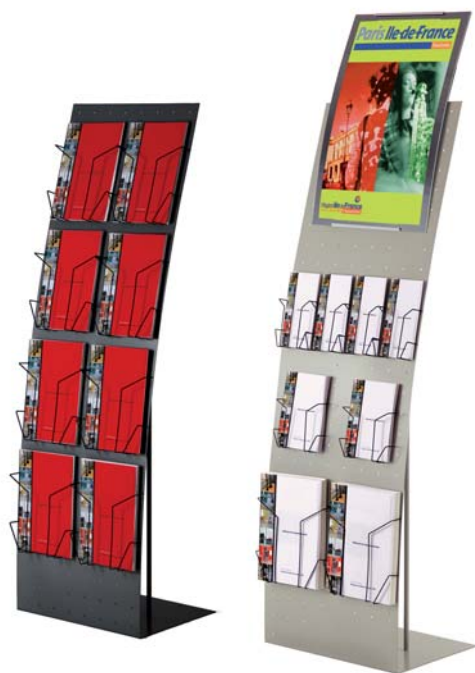

Descriptivo

Presentador modular perforado doble ancho perfilado con o sin bandejas y porta-carteles.







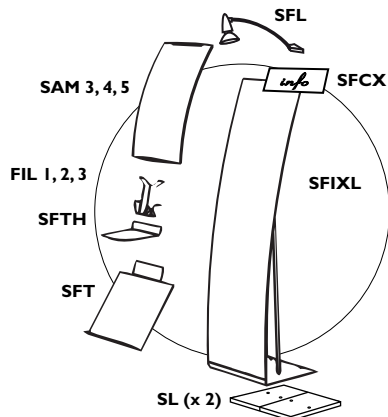



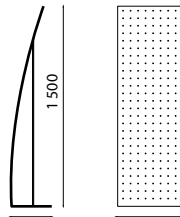

Marca : Signarco®
 Diseñador: Stéphane Geslin
 Fabricado en Francia

Embalaje individual de cartón de alta resistencia de doble pliegue douflin y espuma de protección antideformación

i Se puede fijar al suelo o lastrear (ver accesorios)



i colores a la medida y evolución del producto a partir de 50 piezas

Materiales: acero 2 mm Tratamiento: pintura epoxi industrial alta resistencia				SFIXL Gama SIGNARCO®	
Colores estándares gris 9006 (aluminio)				Peso	Capacidad
Negro					
	SFIXL	Travesaño perforado doble ancho (480 x 1500 mm)		18 kg	
		Accesorios			Bandeja por SFIXL
	FIL1	Bandeja de alambre para documento A4 (Anchura: 230 mm ; Profundidad: 35 mm)		0,08 kg	8
	FIL2	Bandeja de alambre para documento A5 (Anchura: 154 mm ; Profundidad: 35 mm)		0,062 kg	10
	FIL3	Bandeja de alambre para documento 1/3 A4 (Anchura: 108 mm ; Profundidad: 35 mm)		0,054 kg	20
	SAM4	Porta-carteles A4 (21 x 29,7 mm) (Horizontales o verticales)		0,8 kg	
	SAM3	Porta-carteles A3 (29,7 x 42 mm) (Horizontales o verticales)		0,8 kg	
	SAM5	Porta-carteles 40 x 60 (400 x 600 mm) (Vertical)		2,2 kg	
	SAM2	Porta-carteles 60 x 80 (640 x 835 mm) (Vertical)		4,4 kg	
	SL	Lastre (240 x 350 mm)		6,2 kg	
	SFL	Lámpara baja tensión		0,4 kg	
	SFTH	Estante horizontal (200 x 240 mm)		0,9 kg	2
	SFT	Estante inclinada (350 x 460 mm)		2,3 kg	
	Option	Anillos carpeta Ø 15 mm distancia entre ejes de fijación 265 mm		0,04 kg	
	SFCX	Clip "marquaje" (Altura: 120 ; Anchura: 480 mm)		0,45 kg	