

Quick Pop-up kit Technical form & Price list



Description

Quick Pop-up kit

Brand: STAND

This lightweight structure unfolds very easily.





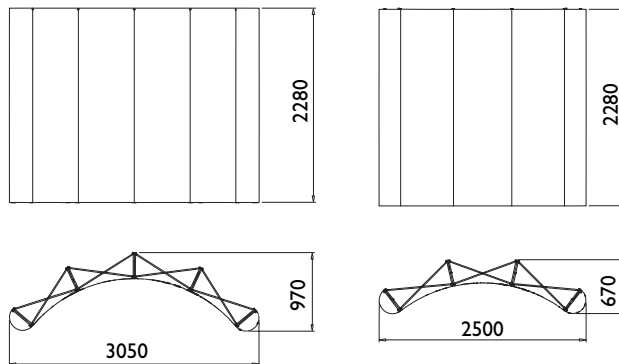

The visuals are easily mounted thanks to a magnetic hook system that is automatically positioned.

i Please provide an illustrator, Xpress or Photoshop file In 1/4 Format I (visual format)

i The visual is totally opaque, even when back-lit

The structure's strength allows several types of mounting



<p>Materials : Anodized aluminium</p>	<p style="text-align: right;">PLIK STAND® Range</p>
 <p>STP03</p>	<p>Quick Pop-up kit, no including printing (ht x L x Prof. : 2280 x 2500 x 670 mm)</p> <p>Flight case (ht x L x Prof. : 900 x 600 x 400 mm)</p> <p style="text-align: right;"></p>
 <p>STP04</p>	<p>Quick Pop-up kit, no including printing (ht x L x Prof. : 2280 x 3050 x 970 mm)</p> <p>Flight case (ht x L x Prof. : 900 x 600 x 400 mm)</p> <p style="text-align: right;"></p>
 <p>STP03-LUM</p>	<p>Quick Pop-up kit, no including printing (ht x L x Prof. : 2280 x 2500 x 670 mm)</p> <p>Flight case (ht x L x Prof. : 900 x 600 x 400 mm)</p> <p>Kit containing 2 extra lamps</p> <p style="text-align: right;"></p>
 <p>STP04-LUM</p>	<p>Quick Pop-up kit, no including printing (ht x L x Prof. : 2280 x 3050 x 970 mm)</p> <p>Flight case (ht x L x Prof. : 900 x 600 x 400 mm)</p> <p>Kit containing 2 extra lamps</p> <p style="text-align: right;"></p>
 <p>STPIMP3/4</p>	<p>Printing with magnetic strip, grainy plastic-coated front</p> <p style="text-align: right;"></p>
 <p>STPIMPFL</p>	<p>Casing for reception desk to be placed on flight case</p> <p style="text-align: right;"></p>